

Complementary 20-V (D-S) Low-Threshold MOSFET

PRODUCT SUMMARY			
	V_{DS} (V)	$r_{DS(on)}$ (Ω)	I_D (A)
N-Channel	20	0.280 @ $V_{GS} = 4.5$ V	1.28
		0.360 @ $V_{GS} = 2.5$ V	1.13
		0.450 @ $V_{GS} = 1.8$ V	1.00
P-Channel	-20	0.490 @ $V_{GS} = -4.5$ V	-1.00
		0.750 @ $V_{GS} = -2.5$ V	-0.81
		1.10 @ $V_{GS} = -1.8$ V	-0.67

FEATURES

- TrenchFET® Power MOSFETS: 1.8-V Rated
- Thermally Enhanced SC-70 Package
- Fast Switching

APPLICATIONS

- Load Switch for Portable Devices

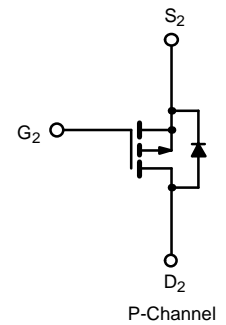
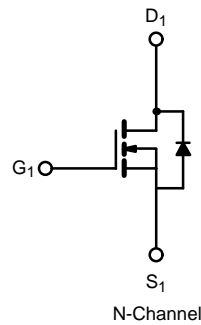
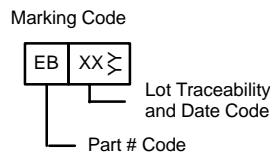
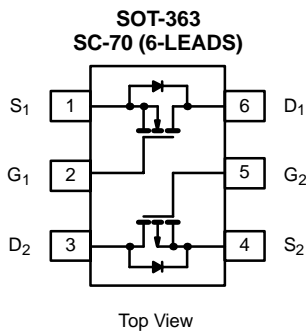

ABSOLUTE MAXIMUM RATINGS ($T_A = 25^\circ\text{C}$ UNLESS OTHERWISE NOTED)						
Parameter	Symbol	N-Channel		P-Channel		Unit
		5 secs	Steady State	5 secs	Steady State	
Drain-Source Voltage	V_{DS}	20		-20		V
Gate-Source Voltage	V_{GS}	± 8		± 8		
Continuous Drain Current ($T_J = 150^\circ\text{C}$) ^a	$T_A = 25^\circ\text{C}$	1.28	1.13	-1.00	-0.88	A
	$T_A = 85^\circ\text{C}$	0.92	0.81	-0.72	-0.63	
Pulsed Drain Current	I_{DM}	4.0		-3.0		
Continuous Source Current (Diode Conduction) ^a	I_S	0.61	0.48	-0.61	-0.48	
Maximum Power Dissipation ^a	$T_A = 25^\circ\text{C}$	0.74	0.57	0.30	0.57	W
	$T_A = 85^\circ\text{C}$	0.38	0.30	0.16	0.3	
Operating Junction and Storage Temperature Range	T_J, T_{stg}	-55 to 150				$^\circ\text{C}$

THERMAL RESISTANCE RATINGS					
Parameter		Symbol	Typical	Maximum	Unit
Maximum Junction-to-Ambient ^a	$t \leq 5$ sec	R_{thJA}	130	170	$^\circ\text{C/W}$
	Steady State		170	220	
Maximum Junction-to-Foot (Drain)	Steady State	R_{thJF}	80	100	

Notes

a. Surface Mounted on 1" x 1" FR4 Board.

SPECIFICATIONS (T_J = 25 °C UNLESS OTHERWISE NOTED)

Parameter	Symbol	Test Condition	Min	Typ	Max	Unit	
Static							
Gate Threshold Voltage	V _{GS(th)}	V _{DS} = V _{GS} , I _D = 100 μA	N-Ch	0.45	1	V	
		V _{DS} = V _{GS} , I _D = -100 μA	P-Ch	-0.45	1		
Gate-Body Leakage	I _{GSS}	V _{DS} = 0 V, V _{GS} = ±8 V	N-Ch		±100	nA	
			P-Ch		±100		
Zero Gate Voltage Drain Current	I _{DSS}	V _{DS} = 16 V, V _{GS} = 0 V	N-Ch		1	μA	
		V _{DS} = -16 V, V _{GS} = 0 V	P-Ch		-1		
		V _{DS} = 16 V, V _{GS} = 0 V, T _J = 85 °C	N-Ch		5		
		V _{DS} = -16 V, V _{GS} = 0 V, T _J = 85 °C	P-Ch		-5		
On-State Drain Current ^a	I _{D(on)}	V _{DS} ≥ 5 V, V _{GS} = 4.5 V	N-Ch	2		A	
		V _{DS} ≤ -5 V, V _{GS} = -4.5 V	P-Ch	-2			
Drain-Source On-State Resistance ^a	r _{DS(on)}	V _{GS} = 4.5 V, I _D = 1.13 A	N-Ch		0.220	0.280	Ω
		V _{GS} = -4.5 V, I _D = -0.88 A	P-Ch		0.400	0.490	
		V _{GS} = 2.5 V, I _D = 0.99 A	N-Ch		0.281	0.360	
		V _{GS} = -2.5 V, I _D = -0.71 A	P-Ch		0.610	0.750	
		V _{GS} = 1.8 V, I _D = 0.20 A	N-Ch		0.344	0.450	
		V _{GS} = -1.8 V, I _D = -0.20 A	P-Ch		0.850	1.10	
Forward Transconductance ^a	g _{fs}	V _{DS} = 10 V, I _D = 1.13 A	N-Ch		2.6	S	
		V _{DS} = -10 V, I _D = -0.88 A	P-Ch		1.5		
Diode Forward Voltage ^a	V _{SD}	I _S = 0.48 A, V _{GS} = 0 V	N-Ch		0.8	1.2	V
		I _S = -0.48 A, V _{GS} = 0 V	P-Ch		-0.8	-1.2	
Dynamic^b							
Total Gate Charge	Q _g	N-Channel V _{DS} = 10 V, V _{GS} = 4.5 V, I _D = 1.13 A P-Channel V _{DS} = -10 V, V _{GS} = -4.5 V, I _D = -0.88 A	N-Ch		1.25	2	nC
Gate-Source Charge	Q _{gs}		N-Ch		0.21		
Gate-Drain Charge	Q _{gd}		P-Ch		0.3		
Turn-On Delay Time	t _{d(on)}	N-Channel V _{DD} = 10 V, R _L = 20 Ω I _D ≅ 0.5 A, V _{GEN} = 4.5 V, R _G = 6 Ω P-Channel V _{DD} = -10 V, R _L = 20 Ω I _D ≅ -0.5 A, V _{GEN} = -4.5 V, R _G = 6 Ω	N-Ch		15	25	ns
Rise Time	t _r		P-Ch		18	30	
			N-Ch		22	35	
Turn-Off Delay Time	t _{d(off)}		P-Ch		25	40	
			N-Ch		25	40	
Fall Time	t _f		P-Ch		15	25	
			N-Ch		12	20	
Reverse Recovery Time	t _{rr}		N-Ch		30	60	
		P-Ch		30	60		

Notes

- a. Pulse test; pulse width ≤ 300 μs, duty cycle ≤ 2%.
b. Guaranteed by design, not subject to production testing.



TYPICAL CHARACTERISTICS (25°C UNLESS NOTED)

N-CHANNEL

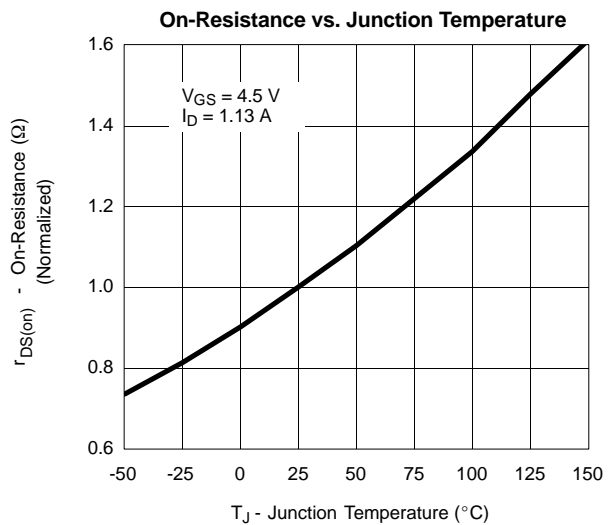
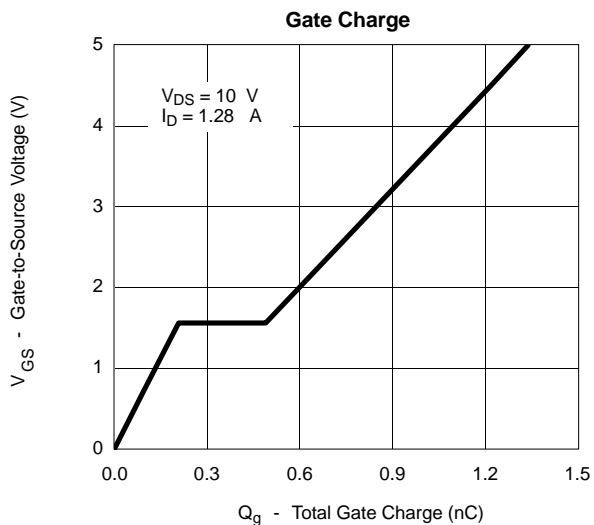
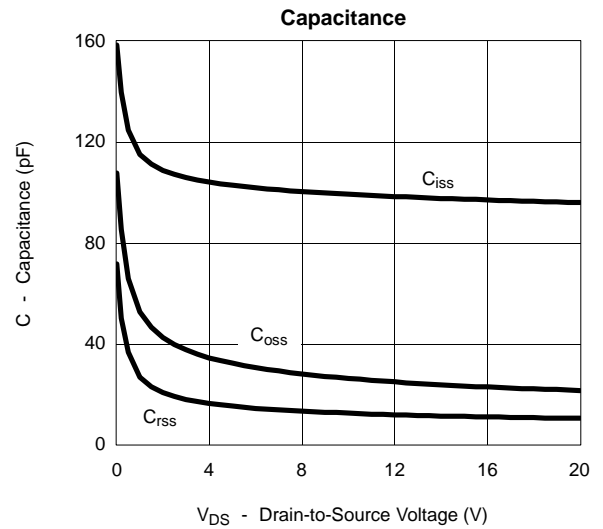
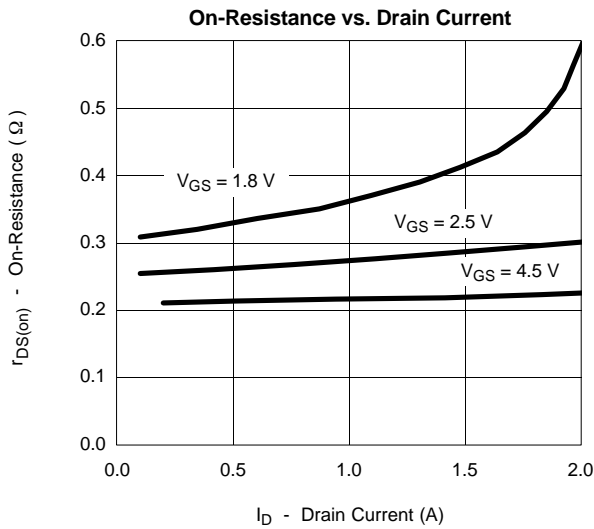
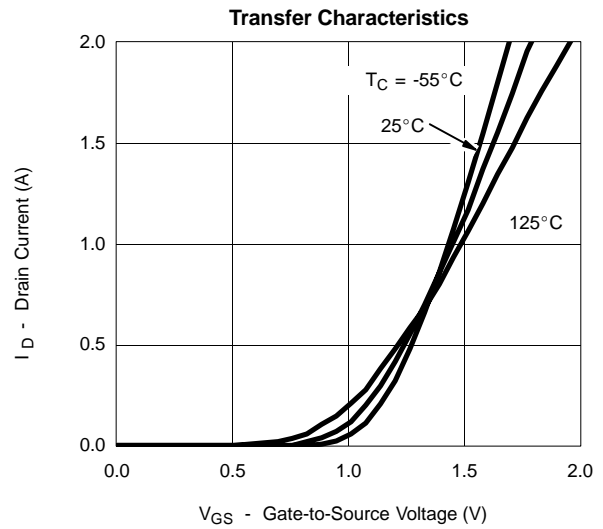
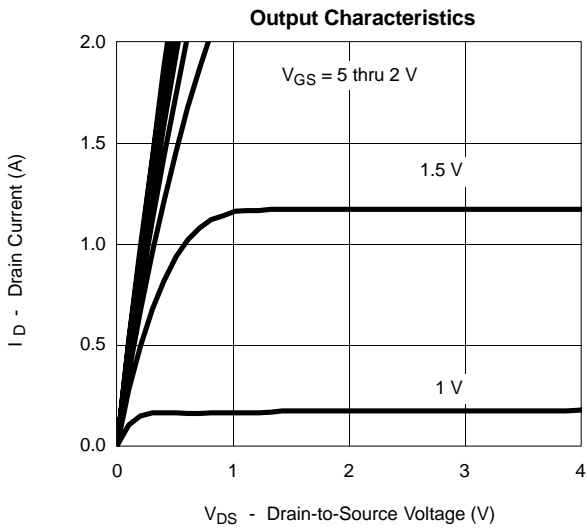



TYPICAL CHARACTERISTICS (25 °C UNLESS NOTED)

N-CHANNEL

Source-Drain Diode Forward Voltage

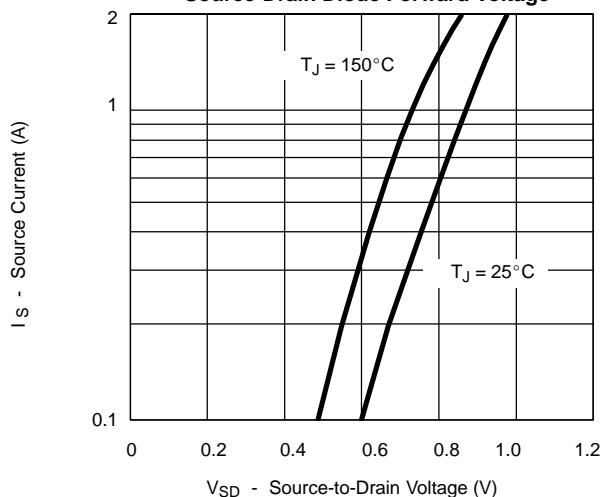

On-Resistance vs. Gate-to-Source Voltage

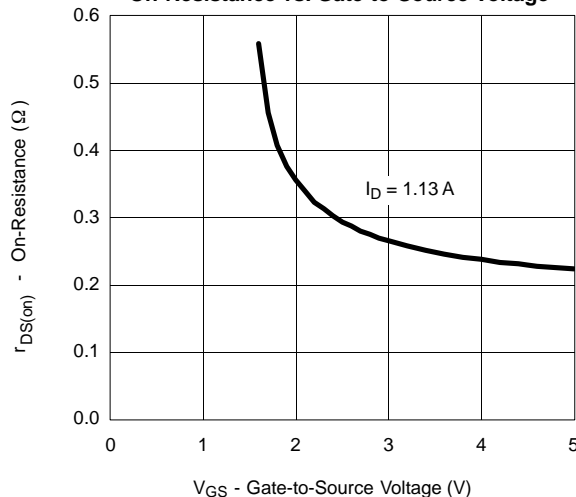

Threshold Voltage

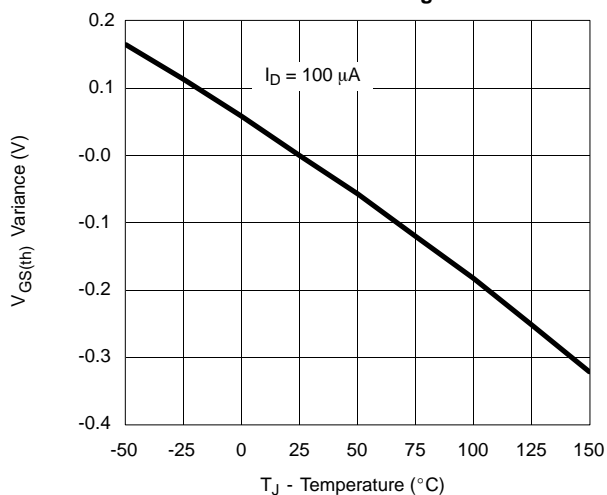

Single Pulse Power, Junction-to-Ambient

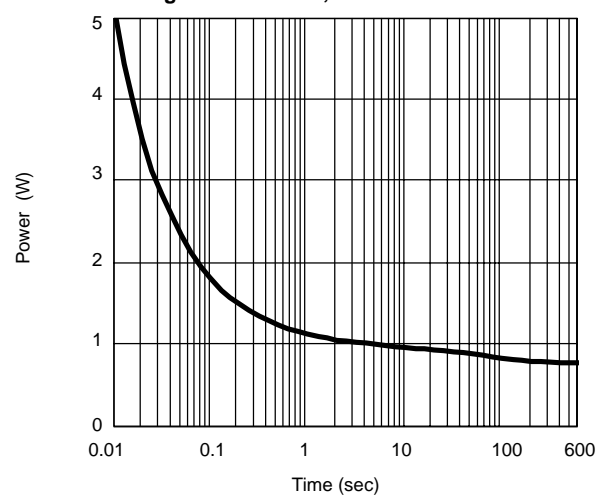

Safe Operating Area, Junction-to-Ambient

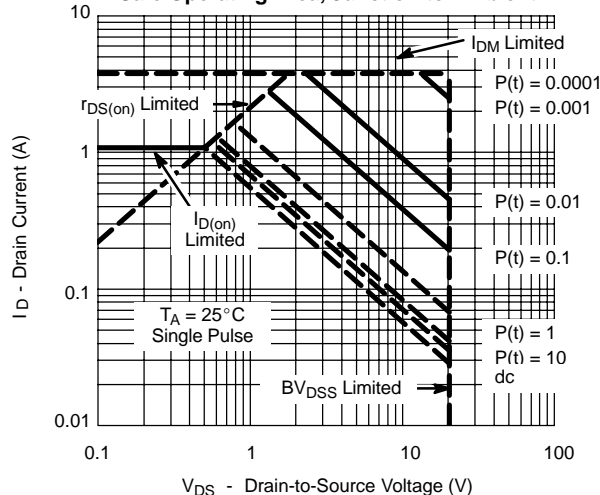



TYPICAL CHARACTERISTICS (25°C UNLESS NOTED)

N-CHANNEL

Normalized Thermal Transient Impedance, Junction-to-Ambient

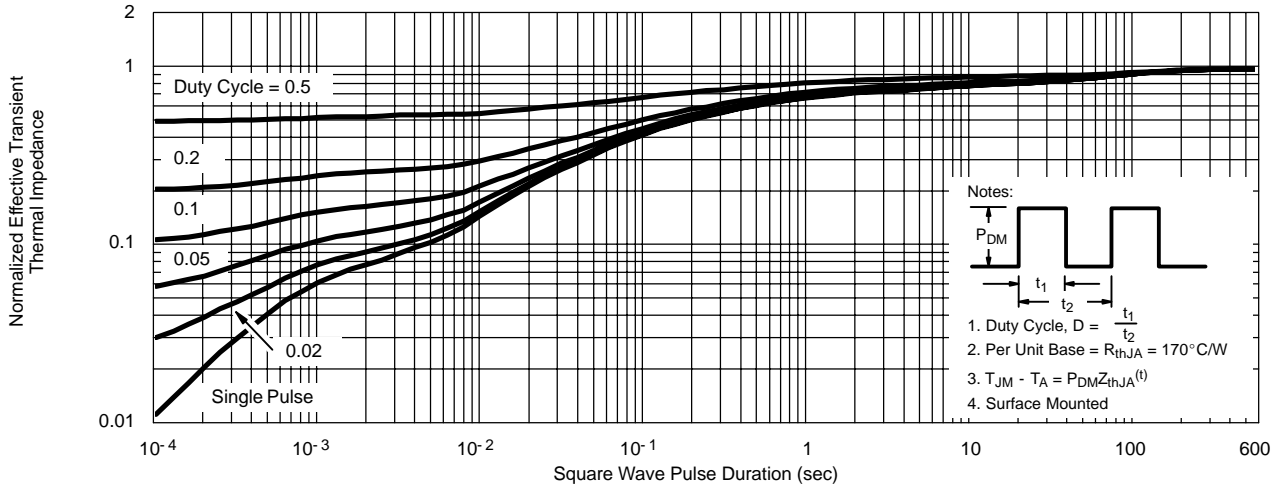

Normalized Thermal Transient Impedance, Junction-to-Foot

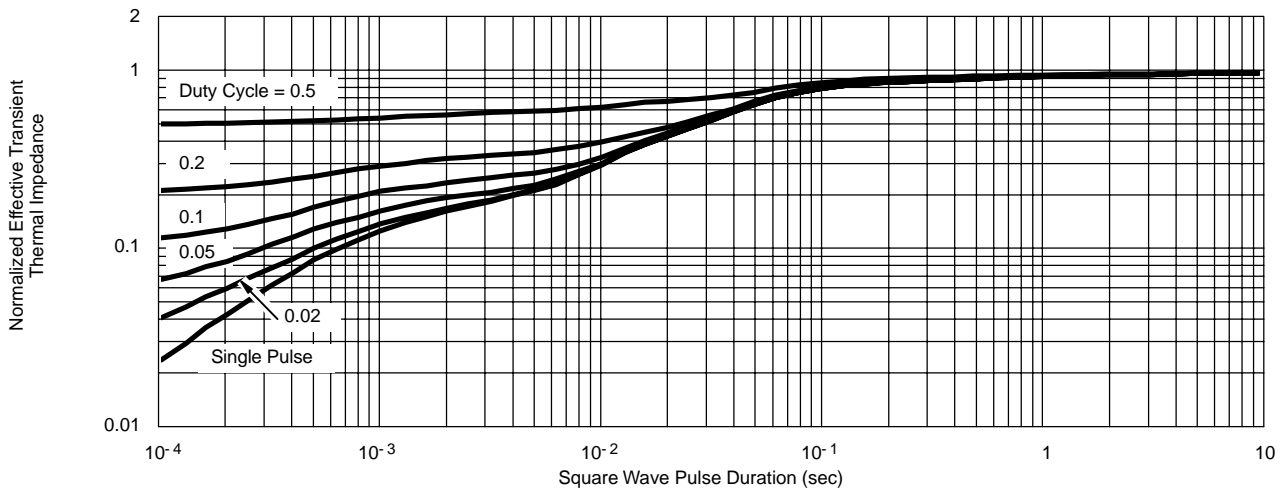

TYPICAL CHARACTERISTICS (25 °C UNLESS NOTED)

P-CHANNEL

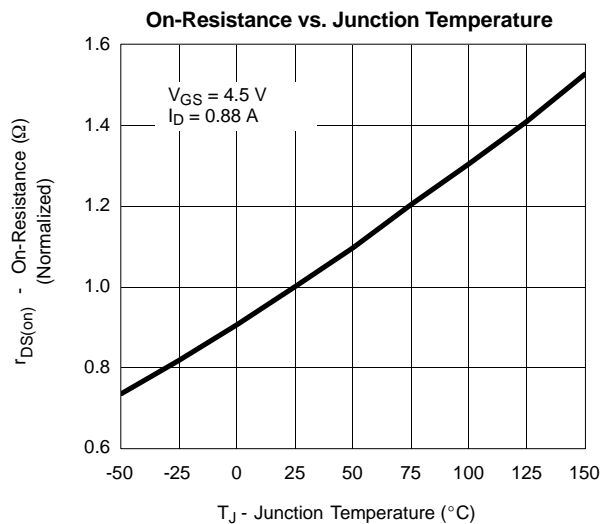
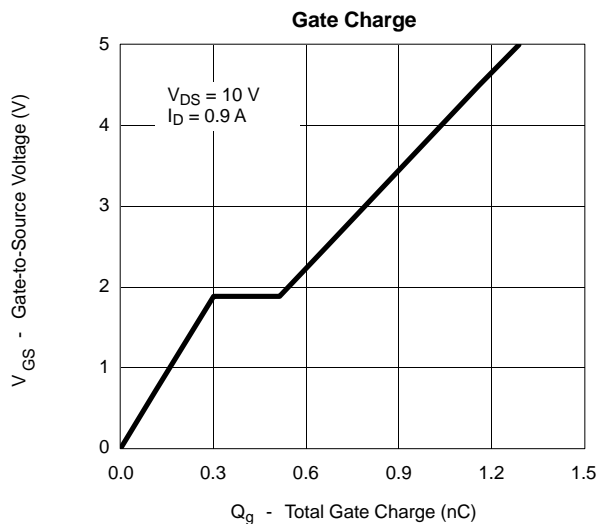
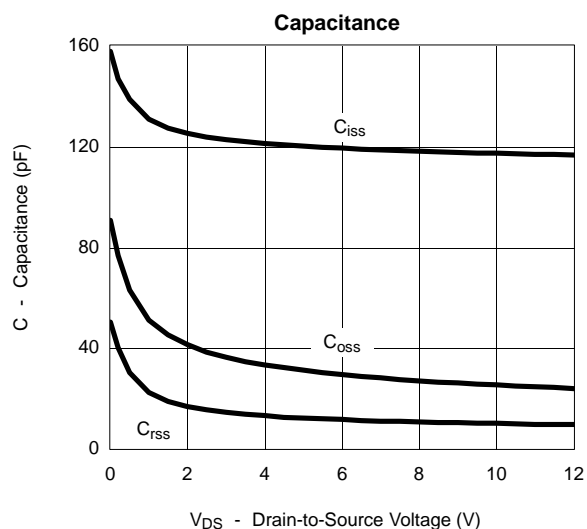
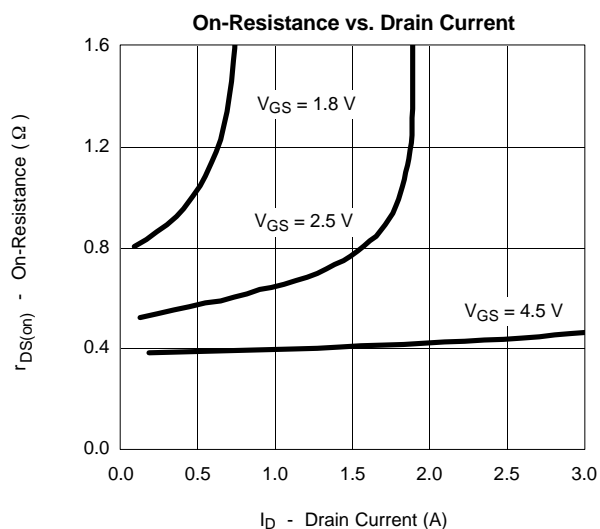
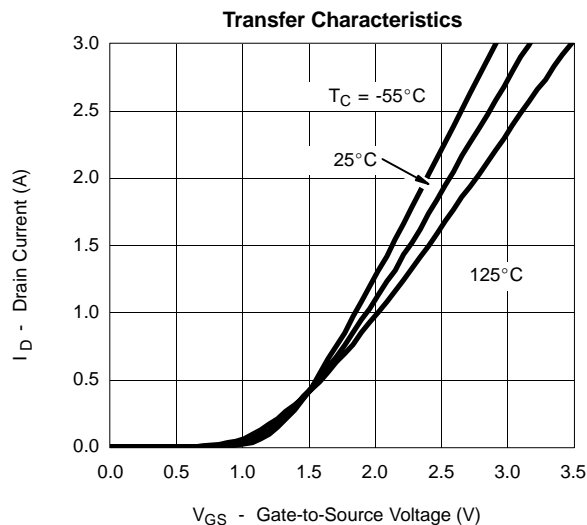
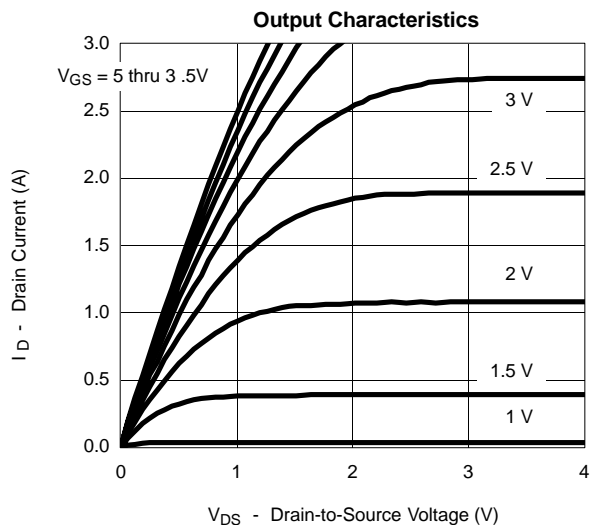



TYPICAL CHARACTERISTICS (25°C UNLESS NOTED) P-CHANNEL

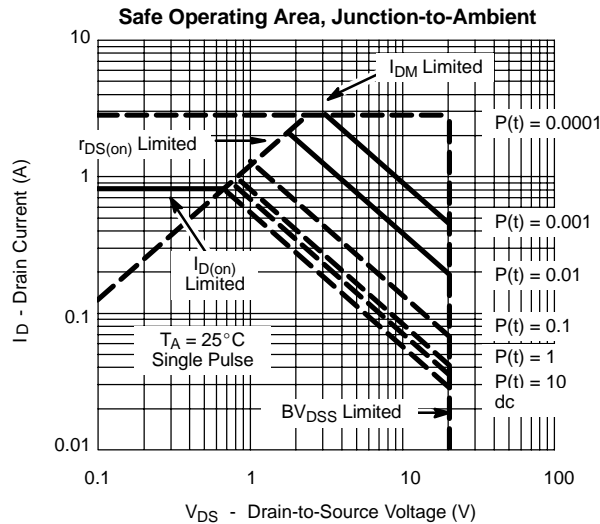
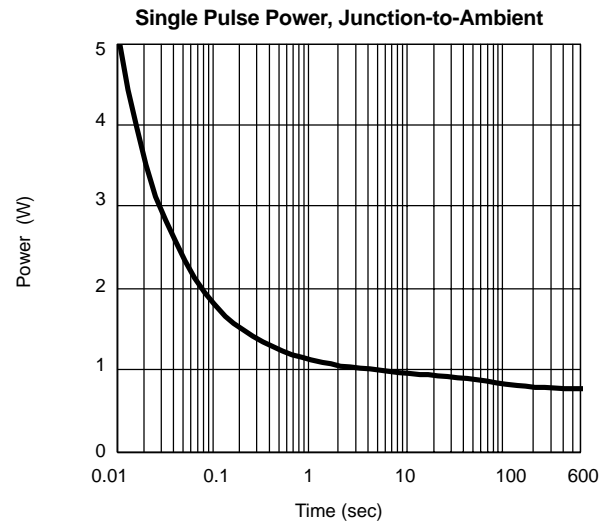
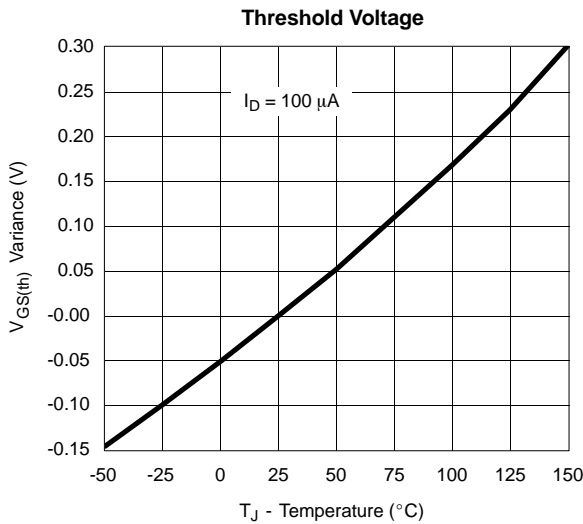
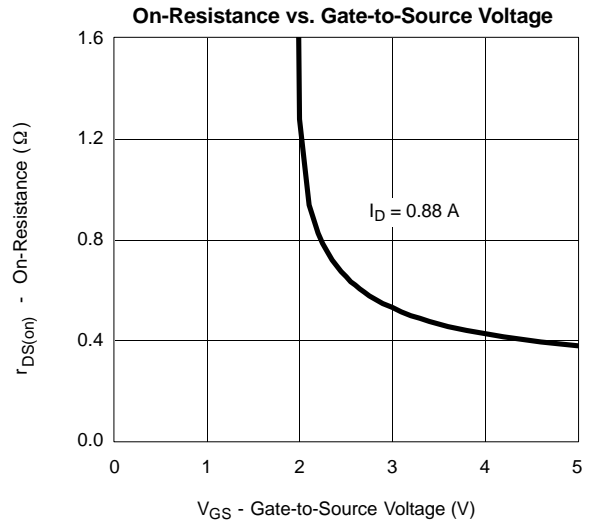
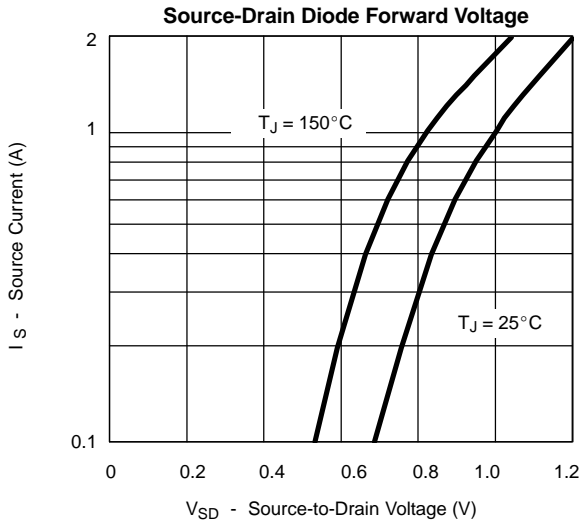

TYPICAL CHARACTERISTICS (25 °C UNLESS NOTED)

P-CHANNEL

Normalized Thermal Transient Impedance, Junction-to-Ambient

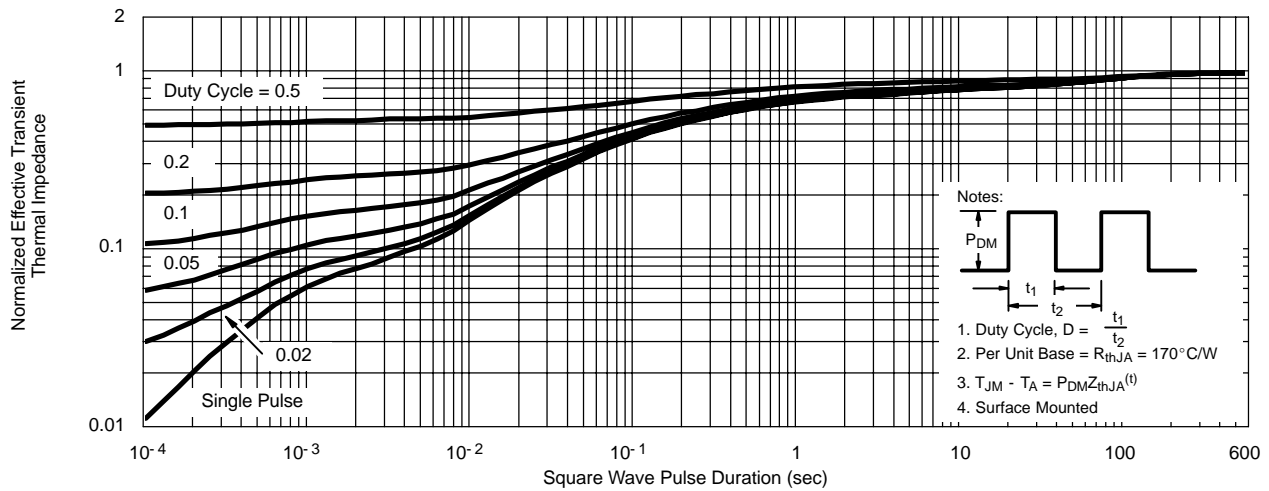

Normalized Thermal Transient Impedance, Junction-to-Foot

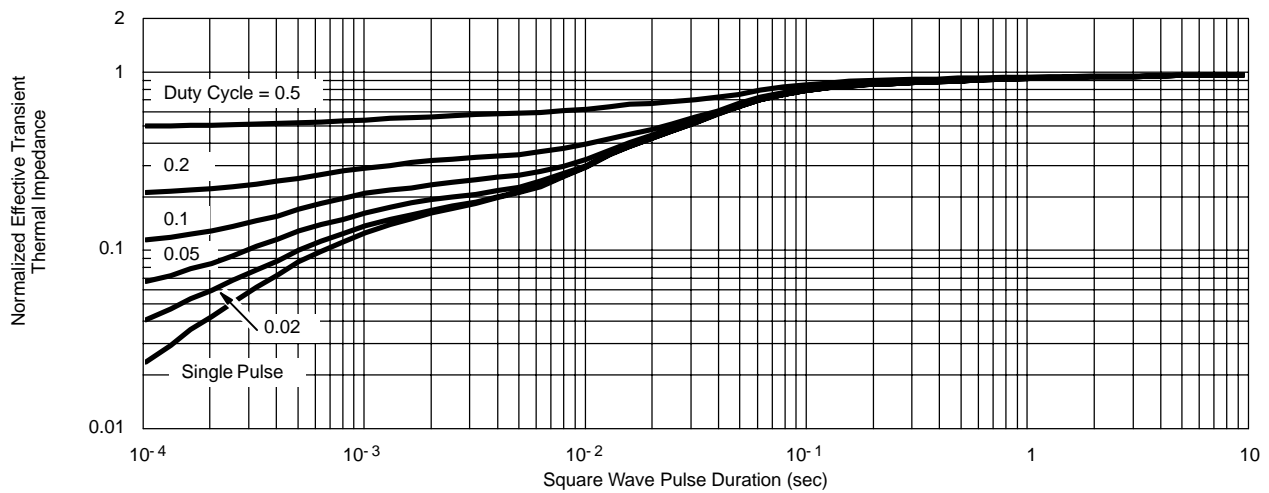



Disclaimer

All product specifications and data are subject to change without notice.

Vishay Intertechnology, Inc., its affiliates, agents, and employees, and all persons acting on its or their behalf (collectively, "Vishay"), disclaim any and all liability for any errors, inaccuracies or incompleteness contained herein or in any other disclosure relating to any product.

Vishay disclaims any and all liability arising out of the use or application of any product described herein or of any information provided herein to the maximum extent permitted by law. The product specifications do not expand or otherwise modify Vishay's terms and conditions of purchase, including but not limited to the warranty expressed therein, which apply to these products.

No license, express or implied, by estoppel or otherwise, to any intellectual property rights is granted by this document or by any conduct of Vishay.

The products shown herein are not designed for use in medical, life-saving, or life-sustaining applications unless otherwise expressly indicated. Customers using or selling Vishay products not expressly indicated for use in such applications do so entirely at their own risk and agree to fully indemnify Vishay for any damages arising or resulting from such use or sale. Please contact authorized Vishay personnel to obtain written terms and conditions regarding products designed for such applications.

Product names and markings noted herein may be trademarks of their respective owners.